

Lone Star

IRON DOORS



MODERN STEEL DOORS & WINDOWS

MODERN

DOORS





DOORS

MODERN

WINDOWS



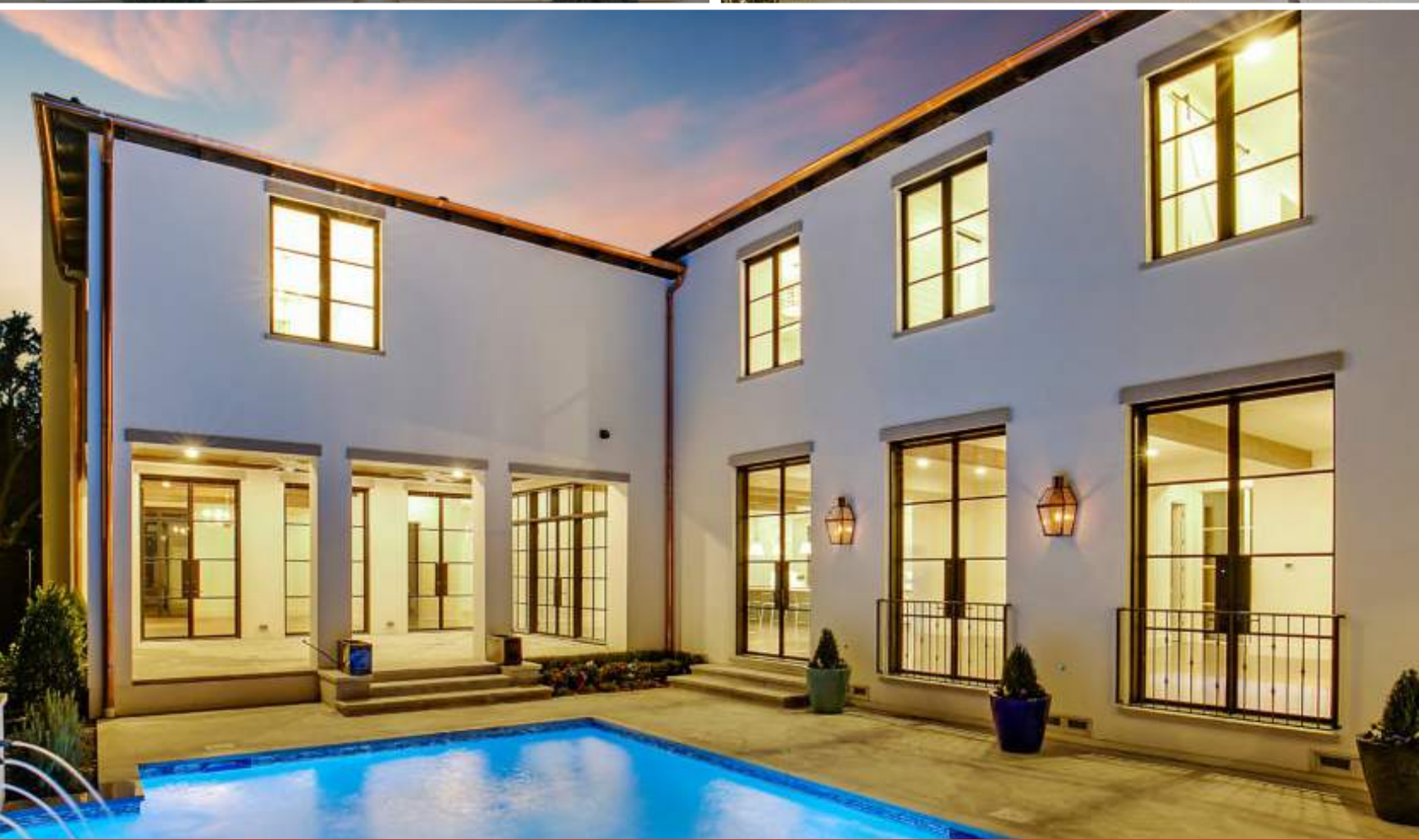

WINDOWS

MODERN

GLASS



Beat the heat. Keep the view.

When the temperature soars, ordinary window glass just can't handle the heat. And tinted glass spoils the view. That is why we use only the highest quality coated glass from Cardinal, LoE³-366. Cardinal's glass has been specially formulated to reject the sun's heat without affecting the view. It lets more light in and keeps more heat out. So your home stays cool and comfortable.



What's more, LoE³-366 provides exceptional fading protection as well. It blocks 95% of the sun's damaging ultraviolet rays (a leading cause of fading), so it will help your furniture, carpets, curtains and wall coverings stay beautiful for years to come.

Tempered Glass Is Tougher Glass

When fully tempered this glass is approximately four times stronger than a piece of annealed glass. More importantly, when tempered breaks it dissociates into small pieces which is considered a break-safe pattern. Cardinal's tempered glass meets important safety codes, including ANSI Z-97.1-2009 and CPSC 16CFR 1201 categories I and II.



THERMAL, PRESSURE
AND BREAK RESISTANT

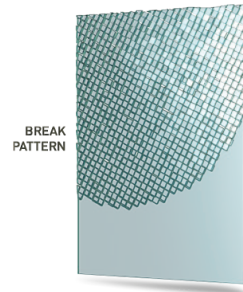

REDUCED RISK
OF INJURY



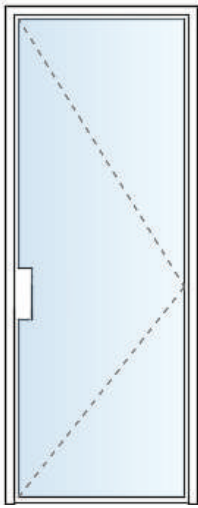

1
3080 Single Door Full Light

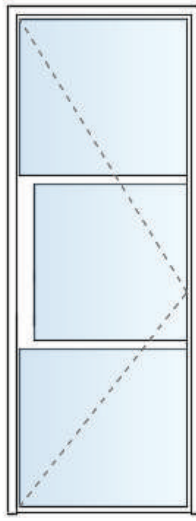

2
3080 Door 3 Light

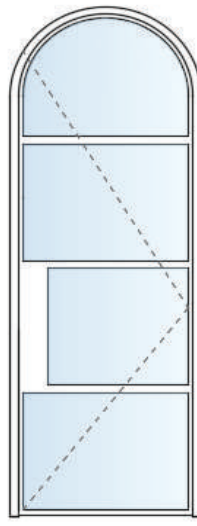

3
3080 Door Arch Top

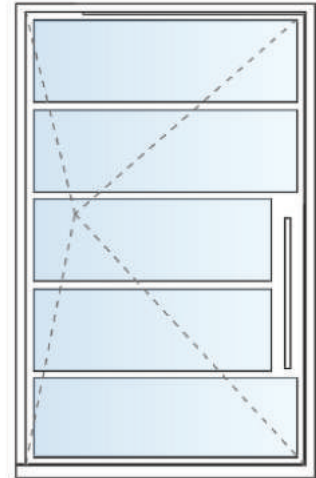

4
4070 Pivot 5 Light Door

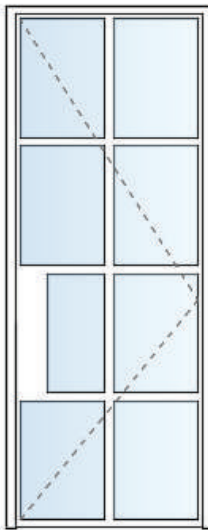

5
3080 2x4 Lights

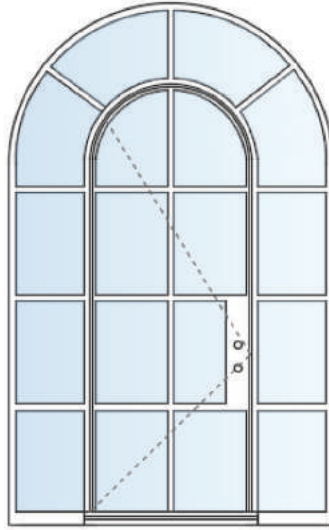

6
Single Door, Sidelight and Transom

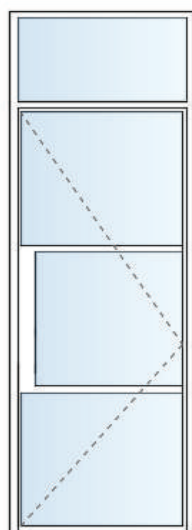

7
Single Door and Transom

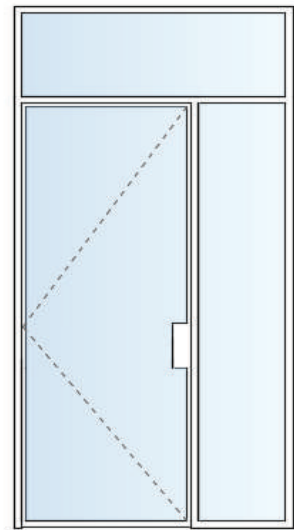

8
Single Door, Sidelight and Transom

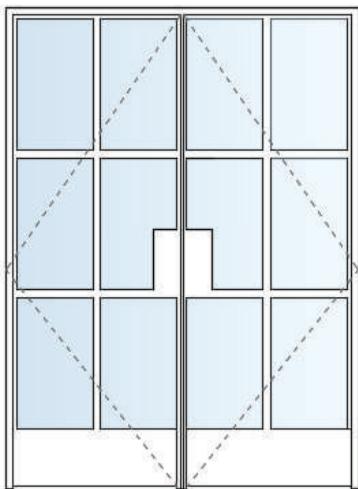

9
6080 Double Door Custom 2x3 Light

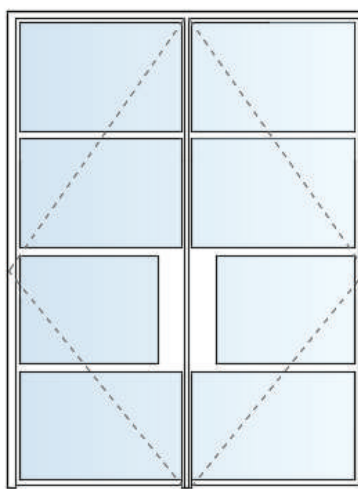

10
6080 Double Door 4 Light

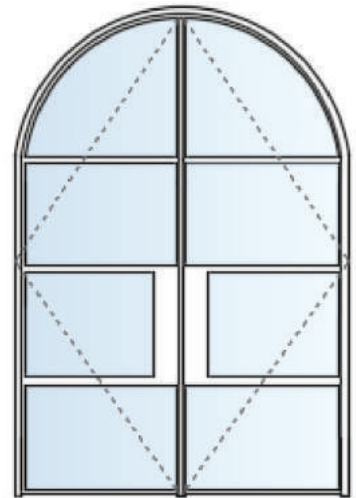

11
6080 Double Arched Door 4 Light

SUMMARY OF TYPES



12
Top-hung outward opening
awning window

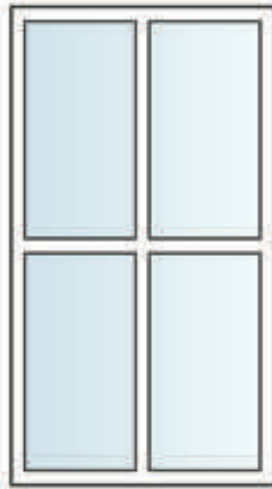

14
Fixed window
with 2x2 lights

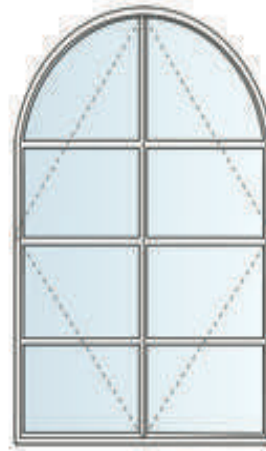

15
Double casement
window with round top

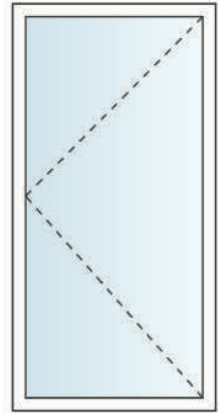

16
Side-hung outswing
casement window



13
Transom

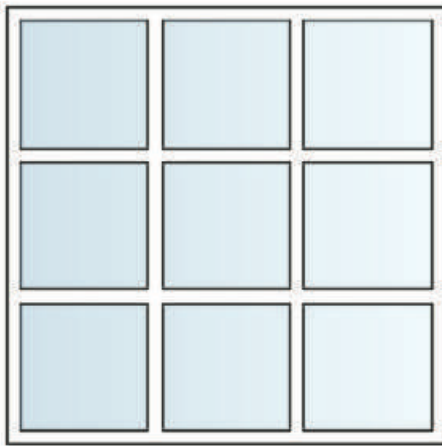

17
Glazed wall system,
9 equal square lights

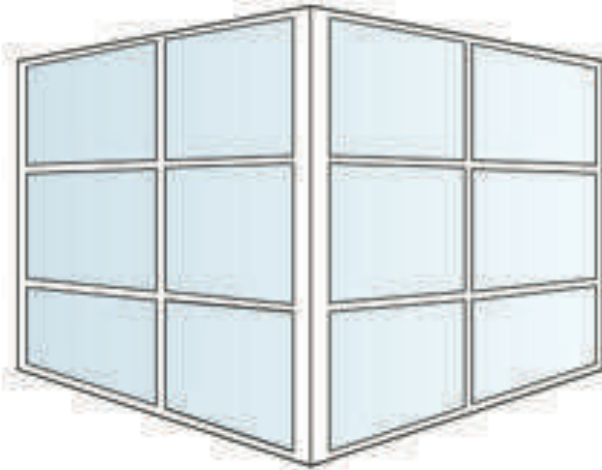

18
Corner window

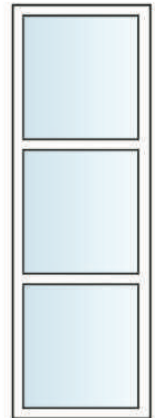

19
Sidelight with
3 lights

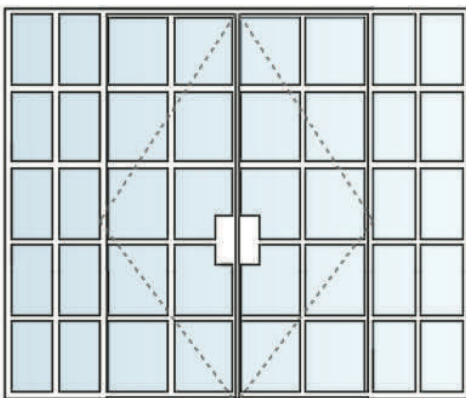

20
Double door and sidelights

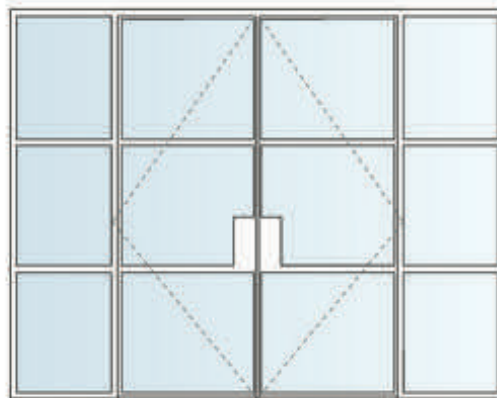

21
Double door with 3 lights
and sidelights

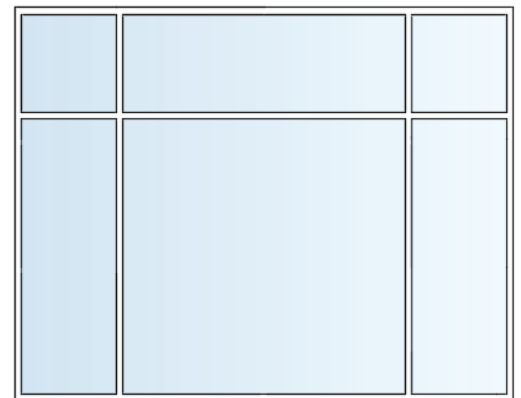

22
Storefront

MODERN

SPECIFICATIONS

Modern Series steel doors and windows feature refined styling with narrow profile, stile and frame sight-lines with many customizable options to accommodate any project's design and energy performance requirements.

- Narrow profile options from 1" to 1-1/2"
- Glass infill from 1/4" to 1" with numerous textures, tints and performance options
- Jamb depth from 3" - 8", custom sizes
- Nail fin or through jamb installation
- Easy-accessible threshold options
- Weatherstrip groove for simple installation and replacement
- Lockbox with large range of system-tested door fittings
- Long-lasting automotive paint finish

Opening types

- Single and double-leaf doors, inward and outward-opening, can be combined with transom or sidelight
- Side-hung and double-vent outward-opening casement windows
- Top-hung and projected top-hung windows, outward-opening
- Pivoted Door
- Folding Doors and windows
- Sliding Doors and windows
- Fixed glazing
- Shower Door

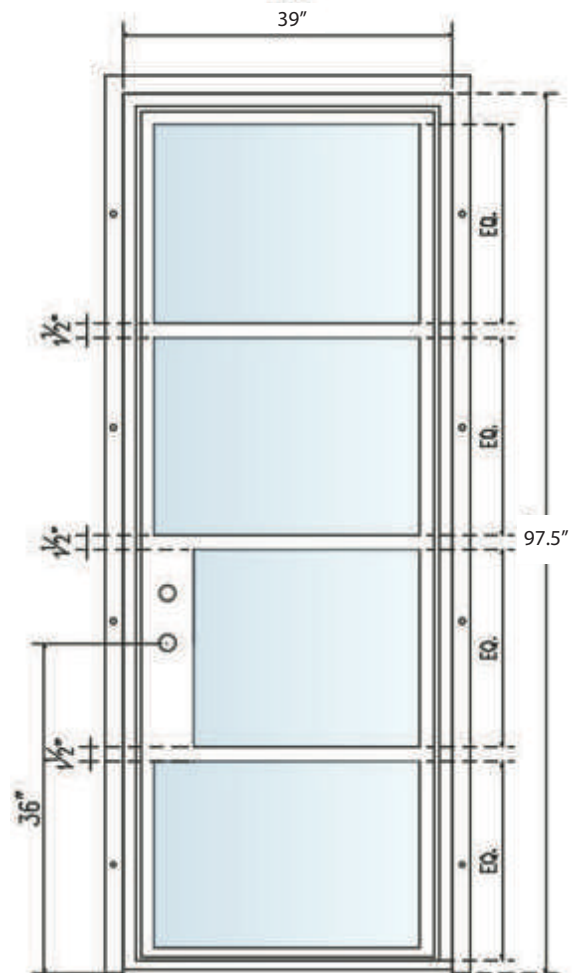

CLASSIC 1 1/2" 3080 Door

- Maximum leaf weight 350 lbs
- Maximum leaf width 48", height 120"
- Energy efficient U-Factor and SHGC
- Wind Load DP 50 Rating
- Custom sizes and designs available
- Installation available

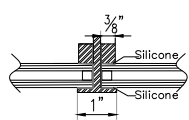
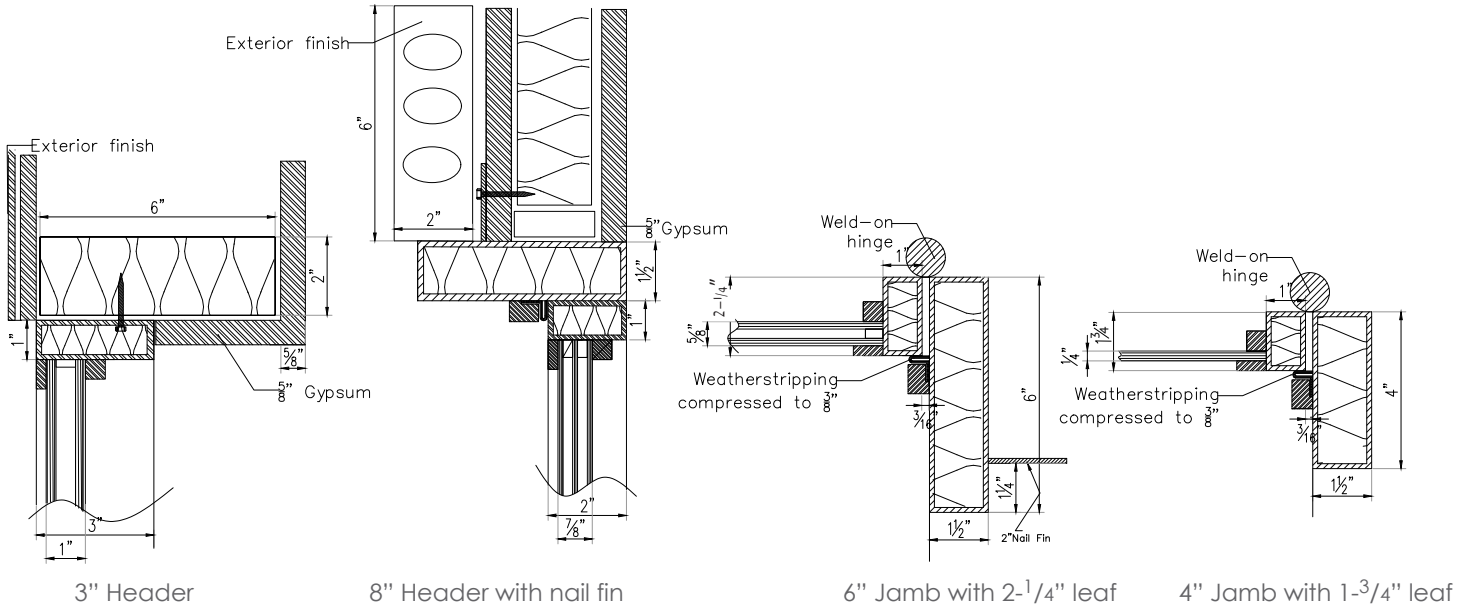

El Flaco 1"

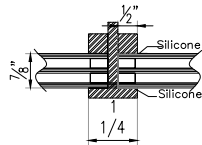

Tech 1-1/4"

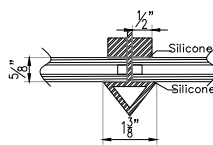

Vintage 1-3/8"

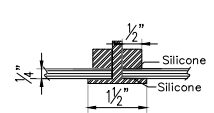

Classic 1-1/2"

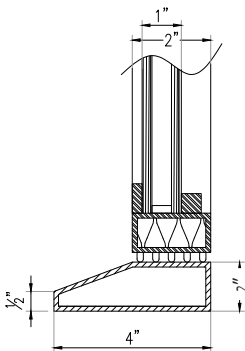

Inswing Fixed

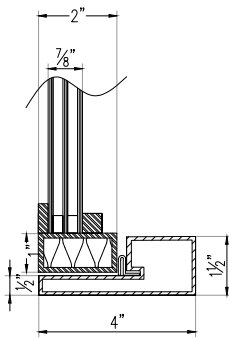

Outswing Bumper

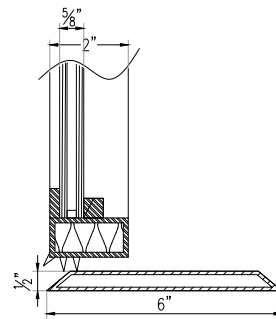

Commercial ADA

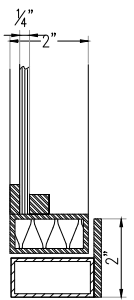

Outswing Casement

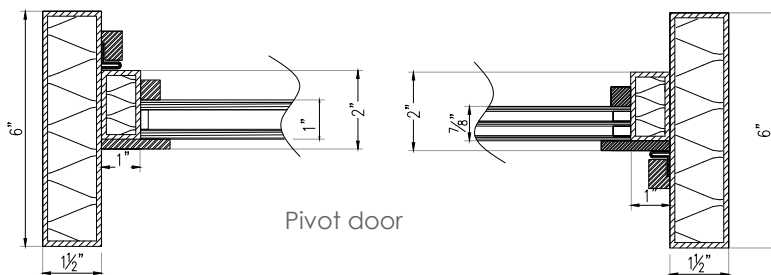

Pivot door

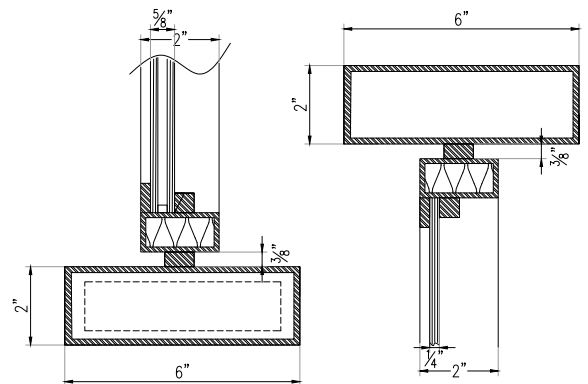

MODERN

STOREFRONT





STOREFRONTS

MODERN

HARDWARE





Paint Finishes

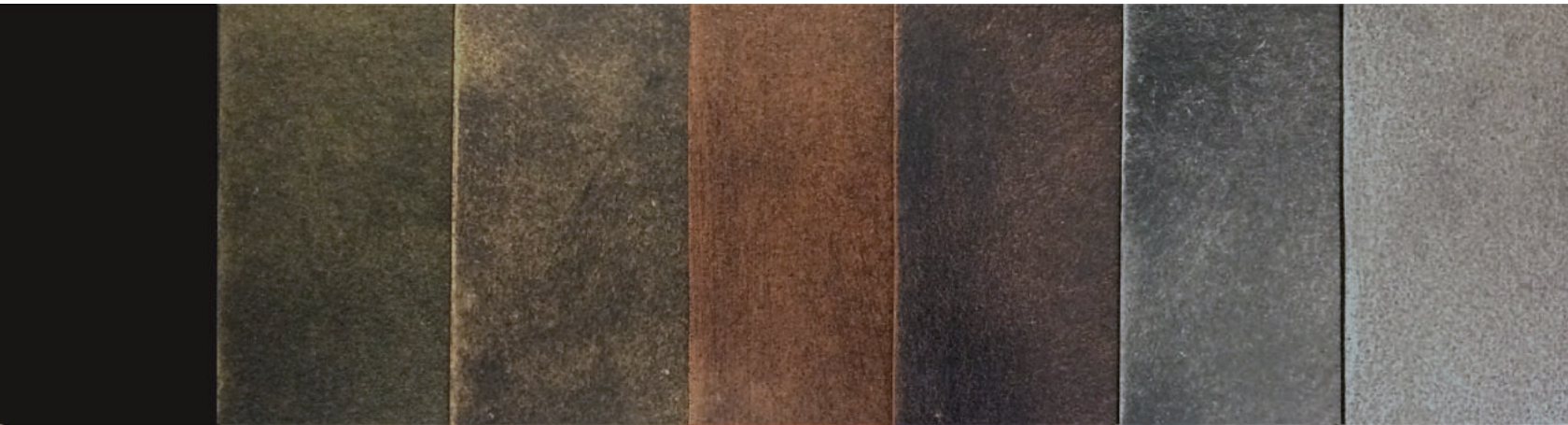

Black

Gold Patina

Pale Gold

Copper Patina

Copper Mist

Pewter

Pewler Patina



SHOWROOM
6121 W. Park Blvd. C-226
Plano, TX 75093

WAREHOUSE
3830 DIVIDEND DR.
GARLAND, TX 75042

(214) 774-4455 | office@lonestairondoors.com